

SANHUA

SEC series EEV Controller Manual/Installation Instructions



CAUTIONS

1. This product may cause an electric shock in handling. Please do not attempt to open it with power turned on.
2. This product should be installed in a place fixed secured by a rack or panel.
3. This product can be used under the following environmental conditions:
 - Indoor
 - Pollution Degree 2
 - At an altitude of 2000m or below
4. Power input must be within the designated ranges.
5. To turn on or turn off power supply for this product, please use the circuit breaker or switch of a standard product of IEC 60947-1 or IEC 60947-3 product and install it within a close distance allowing convenient operation by user provided.
6. An output wire to be used for this product should be inflammable grade FV1(v-1 grade or above). The thickness of the wire should 0.08mm²~1.3 mm²
7. In order to prevent it from an inductive noise, please maintain the high-voltage wire and power wire separated.
8. Please avoid installing the product in a place where a strong magnetism, noise, severe vibration and impact exist.
9. When extending the sensor wire, use a shield wire and do not extend it unnecessary long.
10. The sensor wire and signal wire should be away from the power and load wires using conduits separately installed.
11. Please avoid using the product near a device generating strong high frequency noise (high frequency welding machine, high-frequency sewing machine, high-frequency radiotelegraph, high capacity SCR controller)

1. Basic specifications

Items	Description
Dimension	87(W)mm x 114(H)mm x 30 (D)mm
Power supply	24Vac +10%/-15%, 50/60Hz (SEC611) 24Vdc+10%/-10% (SEC611 & SEC612) Class II
Power consumption	Max 4W at 24Vdc
Connection	Pluggable terminal: Screw M2 Min/Max wire diameter: 0.08 ² ~1.3 mm ² XHP terminal
Input	Pressure sensor
	Temperature sensor
	RUN signal Passive switch signal
Output	Relay output 30Vdc/5A
	EEV (uni-polar) output
Communication	RS 485
Operation	-30~55 °C, Humidity≤95%RH
Storage	-30~55 °C, Humidity≤95%RH
Protection level	IP20

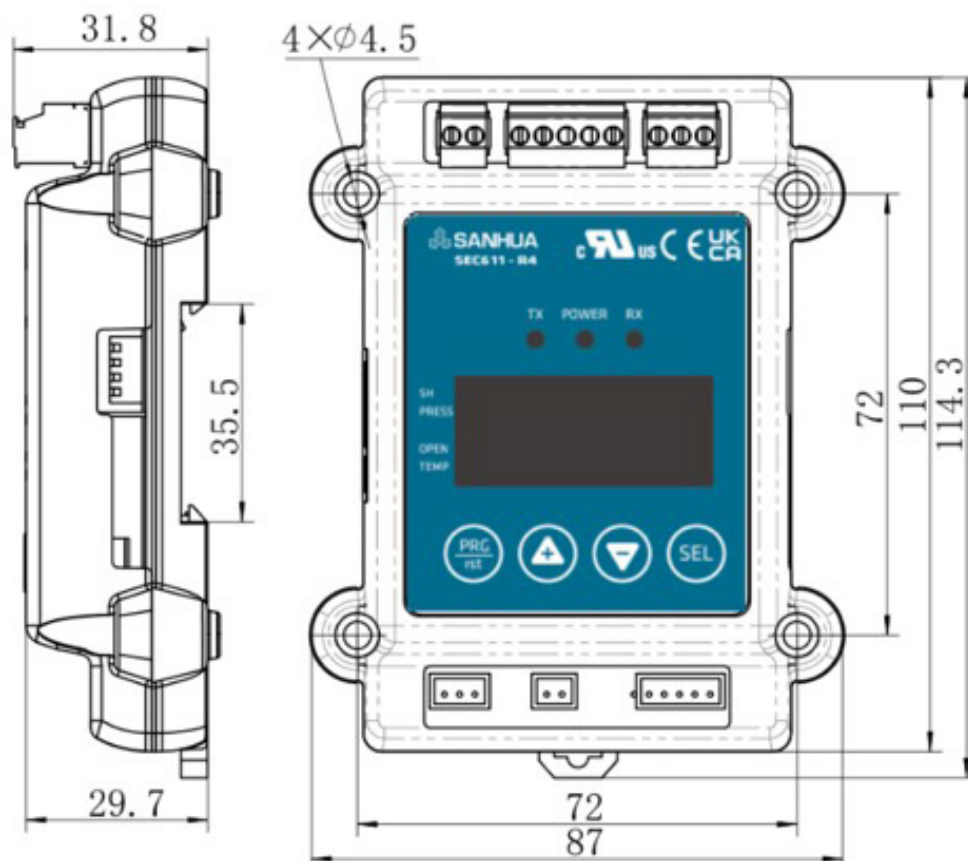

2. Installation Notes

a. DIN slide rail mounting

Mount the controller on the DIN rail by the snap on the back of the controller.
Installed in the electric control cabinet to avoid moisture and dust.

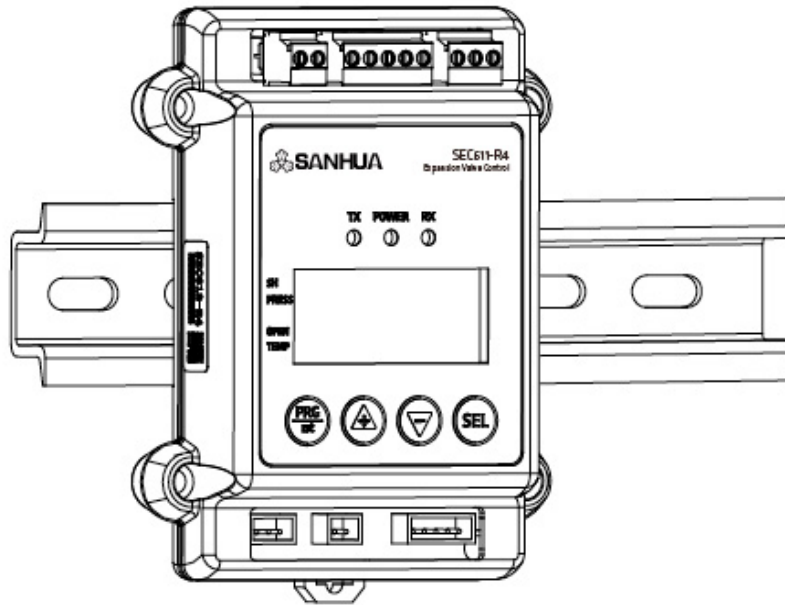

b. Sensors installation

Pressure transmitter / temperature sensor installed on the tube of evaporator outlet. If the system is divided into several evaporators, install pressure transmitter / temperature sensor at each evaporator outlet.

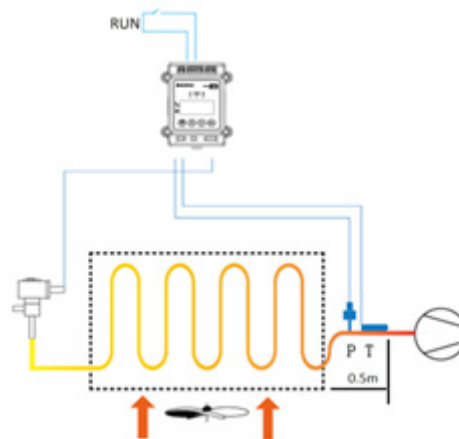

We recommend to install the temperature and pressure sensors within 0.5m from the evaporator to prevent ambient temperature and pressure drop interference for the superheat calculation.

3. Wire Connections

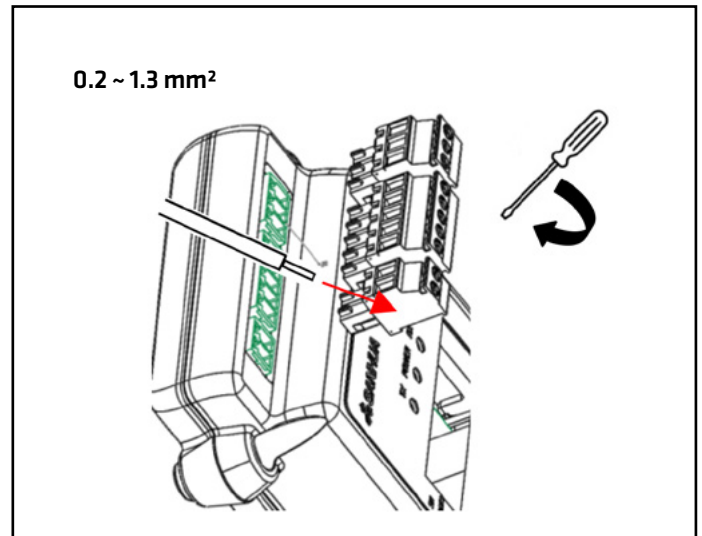
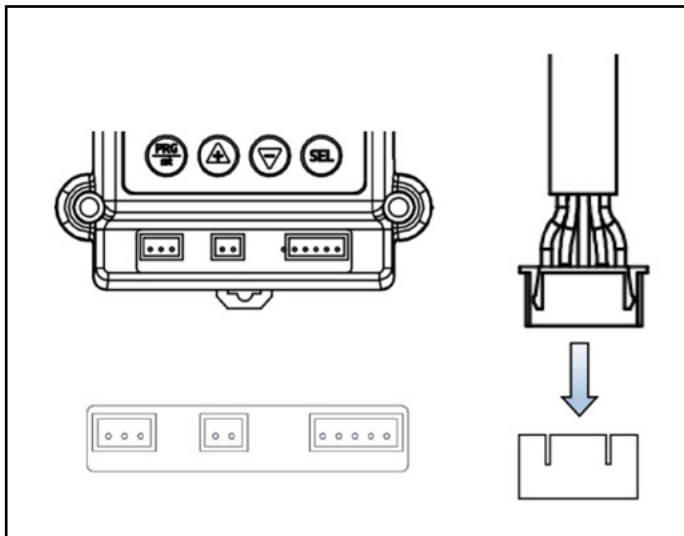

Type	Function	Label	Description	
Pluggable terminal	Power supply	24Vac/Vdc	24V+	SEC611: 24Vdc or 24Vac SEC612: 24Vdc only
			24V-	
		24Vdc	24V+	
			24V-	
	Compressor signal and comm port	RUN	GND	Passive switching signal, open or close synchronously with the compressor, close when using manual mode
			S/W	
		RS485	GND	GND
			B-	TRX-(B)
	Auxiliary relay output	AUX-RLY	N.O.	Normally Open contact
			COM	Common
N.C.			Normally Open contact	
XHP terminal	Pressure sensor	P-SENS	Vcc	Power: YCQB: +5V (RED) YCQC: 10-30Vdc
			S1	S1 YCQB: 0.5-3.5V (White) YCQC: 4-20mA
			GND	GND YCQB: GND (Black) YCQC: N/A
	Temp. sensor	T-SENS	S2	NTCSK/B3970
			GND	
	EEV output	EEV MOTOR		A
				B
				A
			B	
			COM	

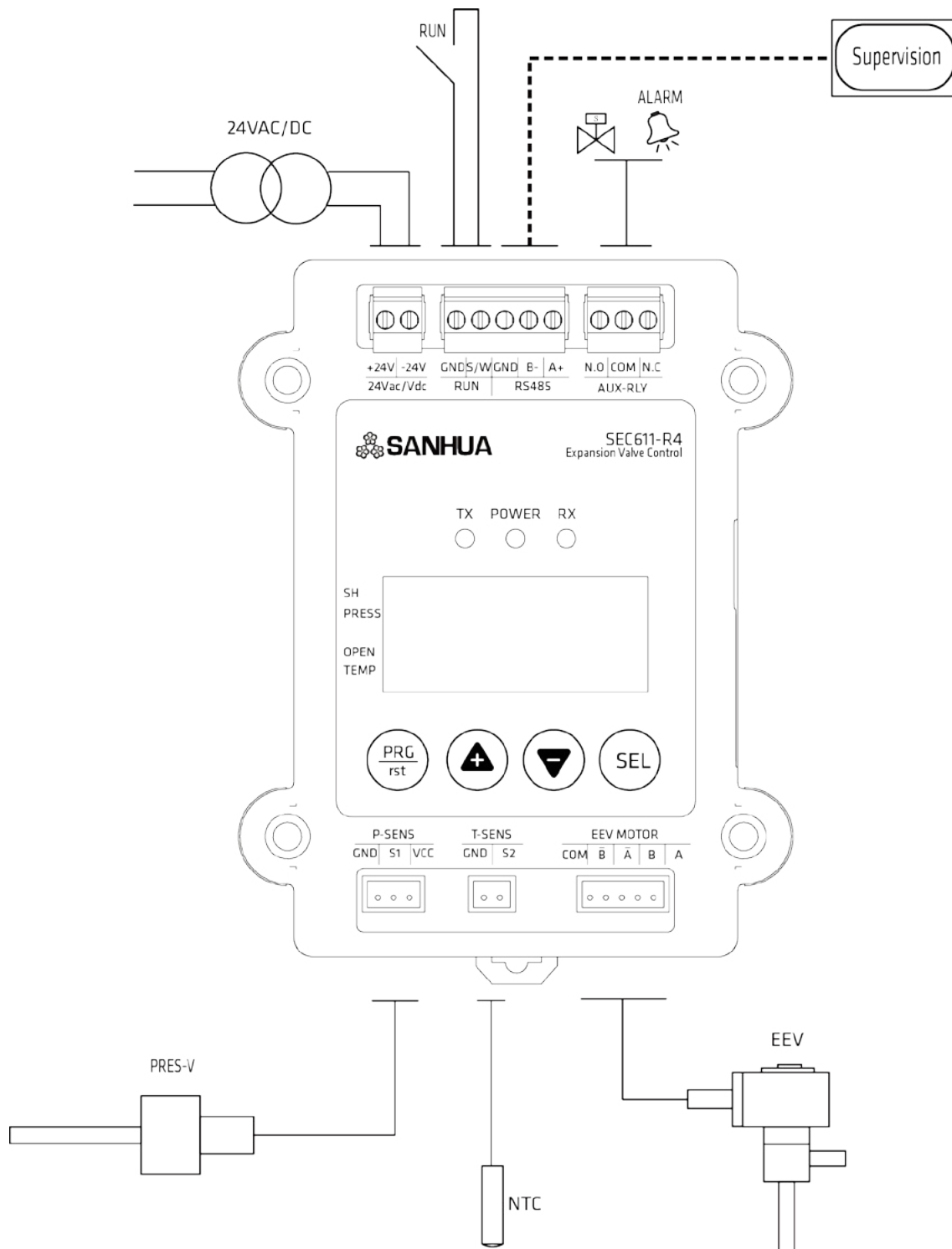

Safety Tips:

1. Do not turn on the power before completing the wiring, cut off the power before changing the wiring.
2. The RUN port (compressor signal) is a passive port. If add a voltage it may cause the controller burn out.
3. Ultracapacitor please series connected to the power supply wire. (Coming soon)
4. If you use a transformer, please ensure the minimum power is 15 VA (for 1 controller + 1 EEV).
5. Min/max wire diameter: 0.2 ~1.3 mm²
6. 24Vdc or 24Vac for SEC611, 24Vdc only for SEC612.

4. DIP SW Setting

All DIP switches are OFF in default mode (suitable for most applications). There are 4 DIP switches, 2, 3 used as a group for selecting EEV type, 1, 4 used as a group for selecting controller operating mode.

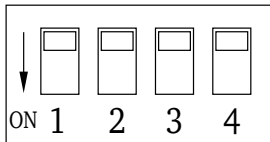

a. EEV type selecting

EEV total steps, excitation speed and excitation mode is determined by the DIP SW2, 3

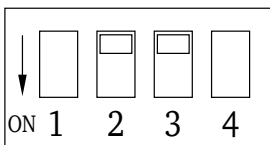

(Default mode)
DIP SW2: OFF, DIP SW3: OFF
1-2 phase, 500 steps, 30pps

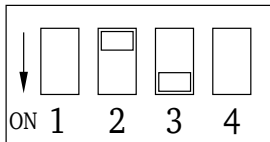

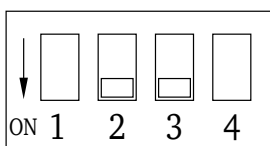

DIP SW2: OFF, DIP SW3: ON
2phase, 2000 steps, 100PPS



DIP SW2: ON, DIP SW3: ON
Custom mode, set by parameter
table 3

b. Control method selecting

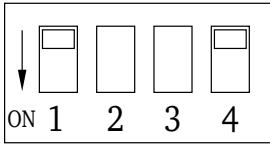
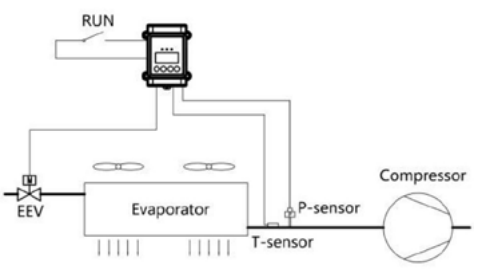
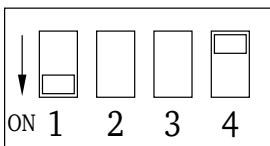
Control method determined by the DIP SW1, 4

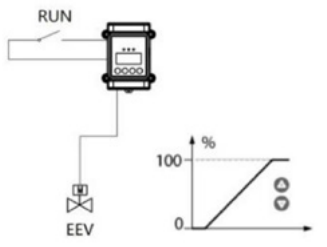
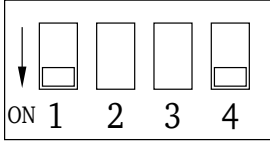
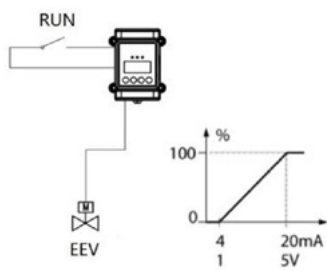
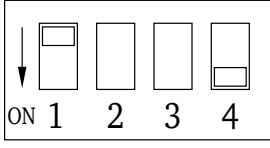
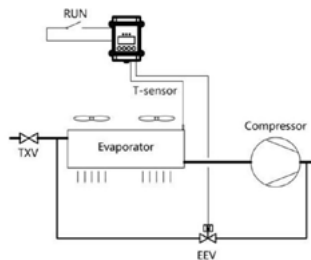
DIP SW position	Description	Schematic
	<ul style="list-style-type: none"> - DIP SW1: OFF, DIP SW4: OFF - Superheat control (Default mode) - Temp./pressure signal ensures system SH stable 	
	<ul style="list-style-type: none"> - DIP SW1: ON, DIP SW4: OFF - Manual operation - Use   Button directly controls the valve opening ratio 	
	<ul style="list-style-type: none"> - DIP SW1: ON, DIP SW4: ON - Drive mode - Use 4-20mA or 1-5V analog signal control 	
	<ul style="list-style-type: none"> - DIP SW1: OFF, DIP SW4: ON - Hot gas bypass (temperature control) 	

Note:

1. While using the manual /drive mode, keep the compressor RUN signal always ON.
2. In drive mode, external 4-20mA or 1-5V analog signal is input through the pressure sensor port.

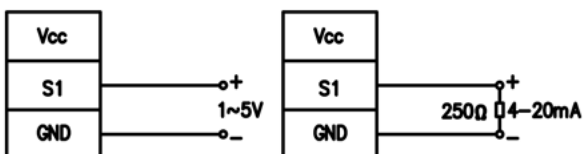

5. Buttons and operation

a. Screen introduction

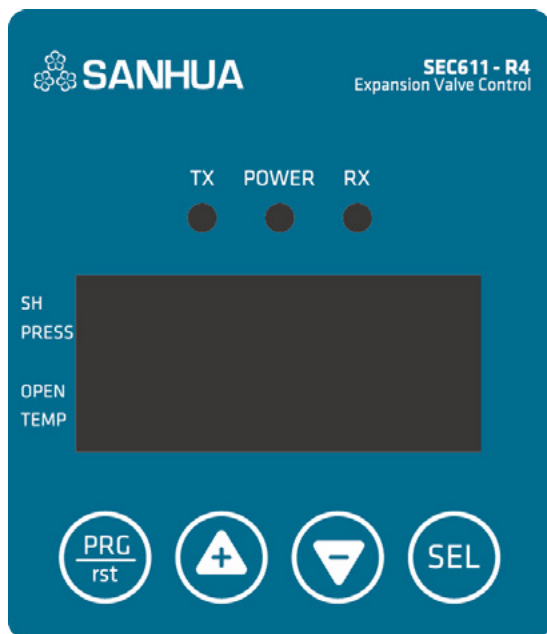

LED	Description
SH	Display current superheat
PRESS	Display pressure sensor value
OPEN	Display current EEV opening
TEMP	Display temperature sensor value
oC /bar	Unit of temp./pressure
	Lighting when alarming
	Flickering at communication mode
POWER	Lighting at power up
TX,RX	Flickering at communication

Use button can switch the display on screen among superheat/pressure/valve opening/temperature (current display is indicated by the cursor pointer)

b. Buttons introduction

Enter the parameter setting interface / return parameter list

Switch screen display parameters, increase/decrease parameters

Confirm key, parameter switch in parameter table, long press save parameter

c. Set/change parameters

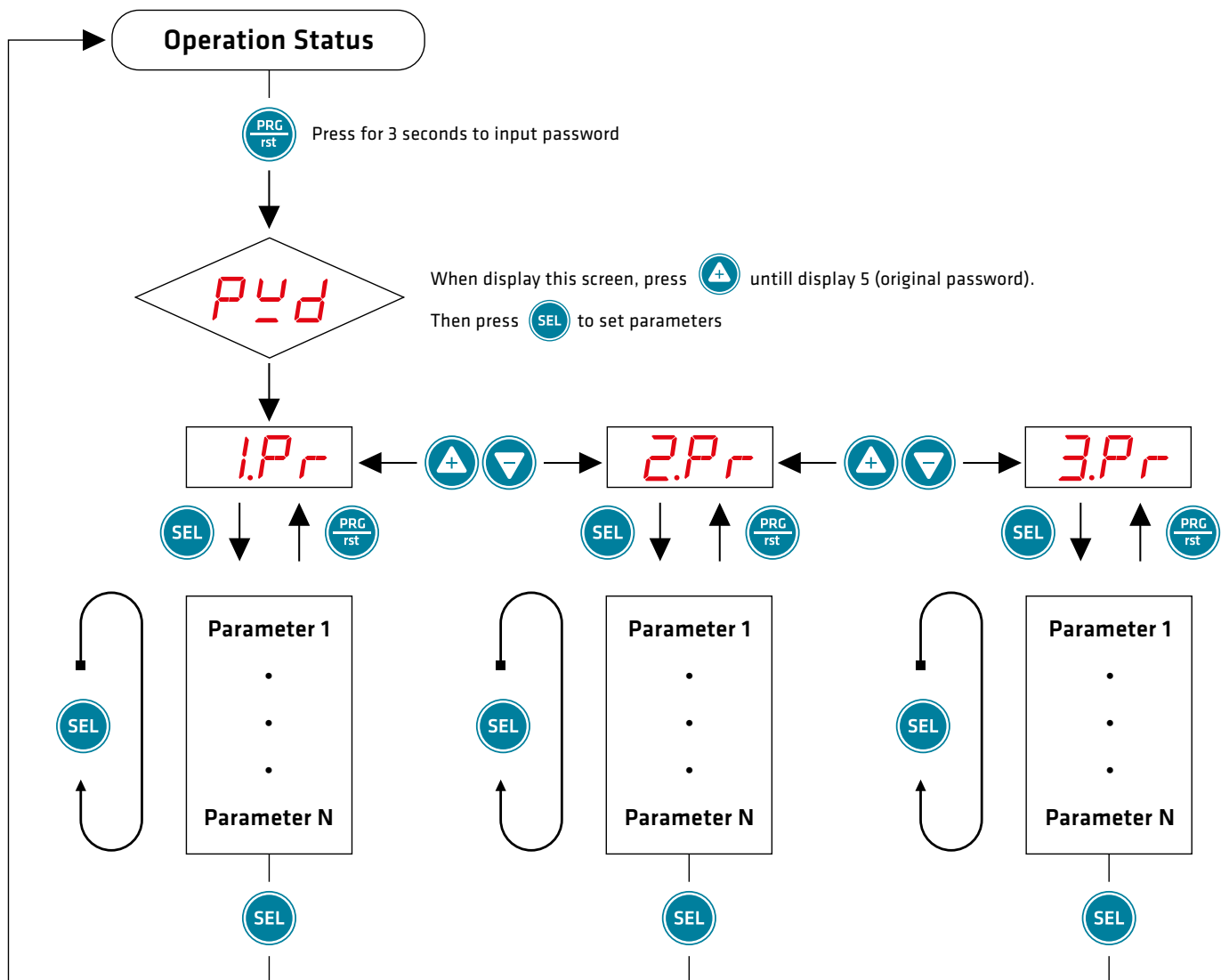

1. During operating status, long press for more than 3s, enter parameter setting mode
2. When screen show *P y d*, press until screen display 5 (original password), then press enter parameters table list
3. *1.P r* means parameters table1, press can select *2.P r* or *3.P r* (switching parameter table)
4. After selected parameters table, press enter the table, if you want to switch other parameter tables, press return to the parameter table select list
5. In parameters table, screen will directly display the parameter code, press can switch the code in parameters table
6. When the screen displays the parameter code which you want to modify, press can modify parameters directly, and press will turn to next parameter or press return to the parameter table select list
7. After finish modifying, long press for 3s will save all settings and return to the operating interface.

d. Main parameter setting

1. Refrigerant selection

Refrigerant data is in *2.Pr*

Add.	Code	Description	Default
40062	<i>rFY</i>	Refrigerant	0(R22)

Now 29 kinds refrigerants is available in controller as below:

0	R22	6	R1234ZE	12	R449A	18	R23	24	R454C
1	R404A	7	R1234YF	13	R452A	19	R407A	25	R455A
2	R410A	8	R290	14	R744(CO2)	20	R407F	26	R454B
3	R134A	9	R450A	15	R744(N2O)	21	R124	27	R452B
4	R407C	10	R513A	16	R32	22	R717	28	R600A
5	R507	11	R448A	17	R245FA	23	R407H		

2. Target superheat setting

Target superheat is in *1.Pr*

Add.	Code	Description	Default
40001	<i>SH</i>	Target superheat	6

If the target SH is too small, may cause liquid hammer in compressor; if the target value is too large, the evaporator energy efficiency will be very low.

3. Start open ratio and duration time

You can find it in *1.Pr*

Add.	Code	Description	Default
40003	<i>blr</i>	Start open ratio	0
40004	<i>sdL</i>	Start open ratio duration time	0

When controller receives compressor RUN signal, EEV will keep the start opening ratio for the duration time.

4. Pump down function

Add.	Code	Description	Default
40025	<i>Pd</i>	Select pump down function and delay time	-1(OFF)
40026	<i>PdP</i>	Pressure set-point for stopping pump down	0.5

If 40025 value is not -1, pump down function is ON



RUN signal = ON => Compressor is ON

RUN signal = OFF (need main controller to cut off) => EEV will close

when low pressure = 40026 bar or delay time = 40025 seconds, the Output Relay changes its position and will inform to cut Off the compressor

5. Reset to factory settings

Add.	Code	Description	Default
	<i>rSt</i>	Reset	0

Reset is in *2Pr* menu, use   to find the parameter *rSt*, input backup-password 913 and long press , all parameters reset to the default from factory.

6. Alarm mode

Code	Description	Code	Description
<i>StP</i>	RUN signal disconnected	<i>nōP</i>	MOP high pressure alarm
<i>PoP</i>	Pressure transmitter disconnected	<i>LoP</i>	LOP Low pressure alarm
<i>PSt</i>	Pressure transmitter short circuit	<i>HSH</i>	High superheat alarm
<i>tōP</i>	Temperature sensor disconnected	<i>LSH</i>	Low superheat alarm
<i>tSt</i>	Temperature sensor short circuit	<i>FrE</i>	Low temperature freezing alarm
		<i>888</i>	Supply voltage out of tolerance

Note *StP* is not alarm, just reminding the compressor RUN signal is disconnected.

Alarm manual reset button is on side face of SEC (EEV driver) shell.

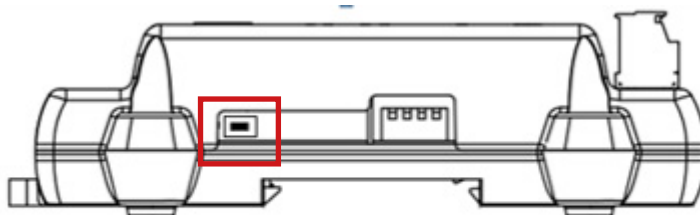

7. Parameters Table

1. *IPr* Refrigerant data is in

Add.	Description	Code	Unit	Step	Min.	Max.	Default
40001	Superheat set point	<i>SH</i>	K	0.1	0.5	30	6
40003	Start open ratio	<i>blr</i>	%	1	0	100	0
40004	Start open ratio duration time	<i>Sdt</i>	Sec	1	0	600	0
40005	P: Proportional gain	<i>dFr</i>	%	0.1	0.1	99.9	3
40006	I: Integral time	<i>irt</i>	Sec	1	0	999	20
40007	D: Derivative time	<i>drt</i>	Sec	1	0	999	4
40008	Low SH alarm mode	<i>LS</i>	0=No use 1=automatic return 2=manual return				1
40009	Low SH alarm value	<i>LSH</i>	K	0.1	0.5	30	0.5
40010	Low SH alarm delay time	<i>LSd</i>	Sec	1	1	300	15
40011	Clear low SH alarm	<i>LSF</i>	K	0.1	1	30.5	3
40012	MOP alarm mode	<i>̄nP</i>	0=No use 1=automatic return 2=manual return				1
40013	MOP alarm pressure	<i>̄nōP</i>	bar	0.1	-1	50	9
40014	MOP alarm delay time	<i>̄nPd</i>	Min	1	1	15	1
40015	Clear MOP alarm	<i>̄nPF</i>	bar	0.1	-1	50	8
40016	High SH alarm mode	<i>HS</i>	0=No use 1=automatic return 2=manual return				0
40017	High SH alarm value	<i>HSH</i>	K	1	10	40	30
40018	High SH alarm delay time	<i>HSD</i>	Min	1	1	600	3
40019	Clear high SH alarm	<i>HSF</i>	K	0.1	7	37	27
40021	Freeze prevention alarm mode	<i>Fr</i>	0=No use 1=automatic return 2=manual return				0
40022	Freeze prevention alarm value	<i>FrE</i>	°C	1	-40	40	0
40023	Freeze prevention alarm delay time	<i>FrD</i>	Sec	1	5	200	30
40024	Clear freeze prevention alarm	<i>FrF</i>	°C	1	-37	43	3
40025	Select pump down function and delay time	<i>Pd</i>	Sec	1	0	180	-1(OFF)
40026	Pressure set-point for stopping pump down	<i>PdP</i>	bar	0.1	-0.5	18	0.5
40027	Pressure low limit alarm mode	<i>LP</i>	0=No use 1=automatic return 2=manual return				0
40028	Pressure low limit alarm value	<i>LōP</i>	bar	0.1	-0.8	17.7	0
40029	Low limit pressure alarm delay time	<i>LPd</i>	Sec	1	5	200	5
40030	Clear low limit pressure alarm	<i>LPF</i>	bar	0.1	-0.5	18	0.3

1) Alarm setting

When alarm setting is ON, if system pressure/temperature exceeds/below the set alarm value and keep more than the delay time, the controller will generate an alarm and act accordingly

2) Mop coefficient for close valve: If 40020=0, controller only have MOP alarm but valve have no action. if 40020 ≠ 0, the larger of value, the slower valve close.

2.2.P.r (Parameters Table2)

Add.	Description	Code	Unit	Step	Min.	Max.	Default
40062	Refrigerant	<i>rFY</i>	0=R22 1=R404A 2=R410A 3=R134a 4=R407C 5=R507 6=R1234ze 7=R1234yf 8=R290 9=R450A 10=R513A 11=R448A 12=R449A 13=R452A 14=R744(CO2) 15=R744(N2O) 16=R32 17=R245fa 18=R23 19=R407A 20=R407F 21=R124 22=R717 23=R407H 24=R454C 25=R455A 26=R454B 27=R452B 28=R600A				0
40063	Pressure sensor MAX. range	<i>PSH</i>	bar	1	0	99	12(Current) 20(Voltage)
40064	Pressure sensor MIN. range	<i>PSL</i>	bar	1	-1	99	-1(Current) 0(S Voltage)
40065	Pressure sensor offset correction	<i>PCr</i>	K	0.1	-9.9	9.9	0
40066	Temp. sensor offset correction	<i>tCr</i>	K	0.1	-20	19.9	0
40067	Password	<i>PCd</i>	/	1	0	999	5
40069	Jerk control ratio	<i>JEY</i>		0.1	0.1	100	100
40070	EEV open ratio upper limit	<i>oPH</i>	%	1	0	100	100
40071	EEV open ratio lower limit	<i>oPL</i>	%	1	0	100	0
40072	Sensor input filter time	<i>oII</i>	/	0.1	1	99.9	1
40073	EEV compulsory open ratio	<i>UCr</i>	%	0.1	0	100	OFF(-1)
40075	EEV reset mode	<i>rSd</i>	0 = Fully close 1 = Fully open to fully close				0
40076	Display mode	<i>dIS</i>	0=1~4 rotation / 1= Superheat 2=Evaporator outlet pressure / 3= Expansion valve open ratio 4= Evaporator outlet temperature / 5= Saturation temperature				1
40077	Run/stop method	<i>rnt</i>	0= Always run / 1= Digital input 2= Communication Run				1
40078	CommunicationID setup	<i>Id</i>	/	1	1	254	1
40079	Communication speed setup	<i>bdr</i>	48(0)=4800 96(1)=9600 192(2)=19200 384(3)=38400				96
	Reset	<i>rSt</i>	/	1	0	999	0

1) set *rSt* to password value (default 5), and then long press  the controller will factory reset.

3. *3Pr* (Parameters Table3)

Addr.	Description	Code	Unit	Step	Min.	Max.	Default
40041	Hold current	<i>EHH</i>	0=OFF		1=ON		0
40042	Expansion valve excitation type	<i>EEd</i>	1-2(0)=1-2 phase excitation		2(1)=2 phase excitation		1-2
40043	Expansion valve total pulse	<i>EEP</i>	pulse	1	10	999	50
40044	Expansion valve open pulse	<i>EEd</i>	pulse	1	0	999	30
40045	EEV drive speed (PPS)	<i>EES</i>	10(0)=10PPS 20(1)=20PPS 30(2)=30PPS 50(3)=50PPS 80(4)=80PPS 100(5)=100PPS 200(6)=200PPS 250(7)=250PPS 500(8)=500PPS				30(2)
40046	Over-driver steps to close EEV	<i>EEt</i>	pulse	1	0	999	8
40047	Over-drive steps to reset EEV	<i>EEr</i>	%	1	0	100	10

- 1) Parameter Table 3 is usually not use, SANHUA standard EEV can directly set by the DIP SW.
If you want modify parameters table 3, please change DIP SW first. (See page 5)
- 2) Because the controller screen display maximum value is 999, so 40043 EEV total steps pulse 50 means 500 steps.

8. Communication Protocol

a. Specification

Item	Description
Transmission line connection	Multiple line
Communication method	RS485 (2-wire, half-duplex)
Baud-rate	Default 9600BPS
Parity, Data, Stop bit	None, 8 data, 1 stop
Protocol Type	Modbus RTU Mode
Function Code	Read Hold Registers (0x03) /Preset Single Register (0x06)
Max. Read Word	32word
Media Type	Belden 9841/9842, LG LIREV-AMESB
Poll interval	100ms

b. Status of Communication table

Add.	Function	Unit	Type	S	SEC601	MMI
40073	EEV compulsory open ratio	-	Analog	INT 16	0.0-100.0	×10
40099	Reset command	-	Analog	INT 16	0:OFF	1:ON
40101	Run/Stop input	-	Analog	INT 16	0:Stop	1:Run
40102	Operation status	-	Analog	INT 16	Refer to below bit	
Bit0	Operation status of EEV	-	Digital	bit	0:OFF	1:ON
Bit1	Aux. relay output	-	Digital	bit	0:OFF	1:ON
40110	Alarm status	-	Analog	INT 16	Refer to below bit	
Bit0	Press. sensor disconnection	-	Digital	bit	0:OFF	1:ON
Bit1	Press. sensor short circuit	-	Digital	bit	0:OFF	1:ON
Bit2	Temp. sensor disconnection	-	Digital	bit	0:OFF	1:ON
Bit3	Temp. sensor short circuit	-	Digital	bit	0:OFF	1:ON
Bit6	MOP alarm	-	Digital	bit	0:OFF	1:ON
Bit7	Low limit pressure alarm	-	Digital	bit	0:OFF	1:ON
Bit8	High superheat alarm	-	Digital	bit	0:OFF	1:ON
Bit9	Low superheat alarm	-	Digital	bit	0:OFF	1:ON
Bit10	Freezing Protection alarm	-	Digital	bit	0:OFF	1:ON
40111	Present Superheat	K	Analog	INT 16		×10
40112	Present saturation temperature	C	Analog	INT 16		×10
40113	Present pressure	bar	Analog	INT 16	-1.0~1.0	×10
40114	Present temperature	C	Analog	INT 16	-100.0~100.0	×10
40116	EEV open ratio	%	Analog	INT 16	0.0~100.0	×10

SANHUA