

SANHUA

SEC series EEV Controller Manual/Installation Instructions



CAUTIONS

1. This product may cause an electric shock in handling. Please do not attempt to open it with power turned on.
2. This product should be installed in a place fixed secured by a rack or panel.
3. This product can be used under the following environmental conditions:
 - Indoor
 - Pollution Degree 2
 - At an altitude of 2000m or below
4. Power input must be within the designated ranges.
5. To turn on or turn off power supply for this product, please use the circuit breaker or switch of a standard product of IEC 60947-1 or IEC 60947-3 product and install it within a close distance allowing convenient operation by user provided.
6. An output wire to be used for this product should be inflammable grade FV1(v-1 grade or above). The thickness of the wire should 0.08mm²~1.3 mm²
7. In order to prevent it from an inductive noise, please maintain the high-voltage wire and power wire separated.
8. Please avoid installing the product in a place where a strong magnetism, noise, severe vibration and impact exist.
9. When extending the sensor wire, use a shield wire and do not extend it unnecessary long.
10. The sensor wire and signal wire should be away from the power and load wires using conduits separately installed.
11. Please avoid using the product near a device generating strong high frequency noise (high frequency welding machine, high-frequency sewing machine, high-frequency radiotelegraph, high capacity SCR controller)

1. Basic specifications

| Items | Description |
|-------------------|---------------------------------------------------------------------------------------------------------------|
| Dimension | 87(W)mm x 114(H)mm x 30 (D)mm |
| Power supply | 24Vac +10%/-15%, 50/60Hz (SEC611) 24Vdc+10%/-10% (SEC611 & SEC612) Class II |
| Power consumption | Max 4W at 24Vdc |
| Connection | Pluggable terminal: Screw M2 Min/Max wire diameter: 0.08 ² ~1.3 mm ² XHP terminal |
| Input | Pressure sensor |
| | Temperature sensor |
| | RUN signal Passive switch signal |
| Output | Relay output 30Vdc/5A |
| | EEV (uni-polar) output |
| Communication | RS 485 |
| Operation | -30~55 °C, Humidity≤95%RH |
| Storage | -30~55 °C, Humidity≤95%RH |
| Protection level | IP20 |

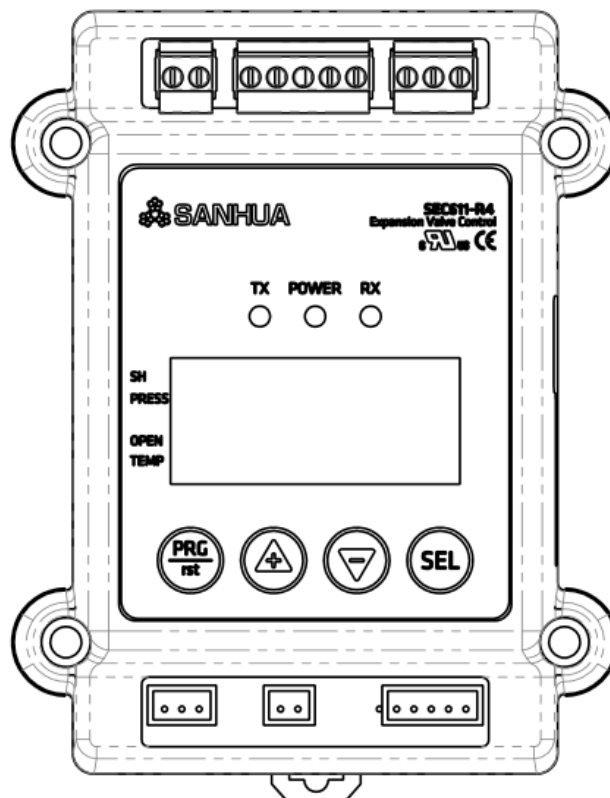

2. Installation Notes

a. DIN slide rail mounting

Mount the controller on the DIN rail by the snap on the back of the controller.
Installed in the electric control cabinet to avoid moisture and dust.

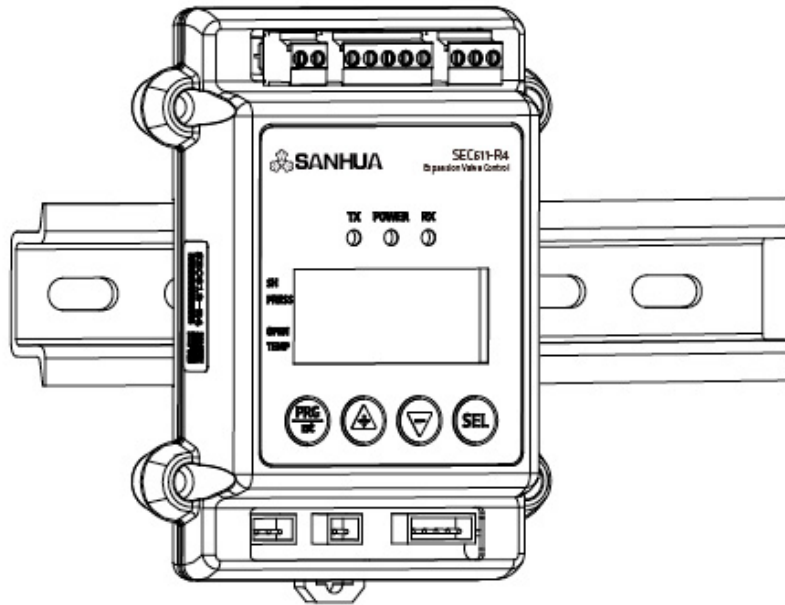

b. Sensors installation

Pressure transmitter / temperature sensor installed on the tube of evaporator outlet. If the system is divided into several evaporators, install pressure transmitter / temperature sensor at each evaporator outlet.

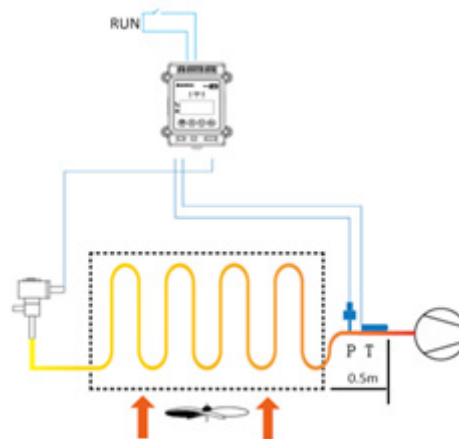

We recommend to install the temperature and pressure sensors within 0.5m from the evaporator to prevent ambient temperature and pressure drop interference for the superheat calculation.

3. Wire Connections

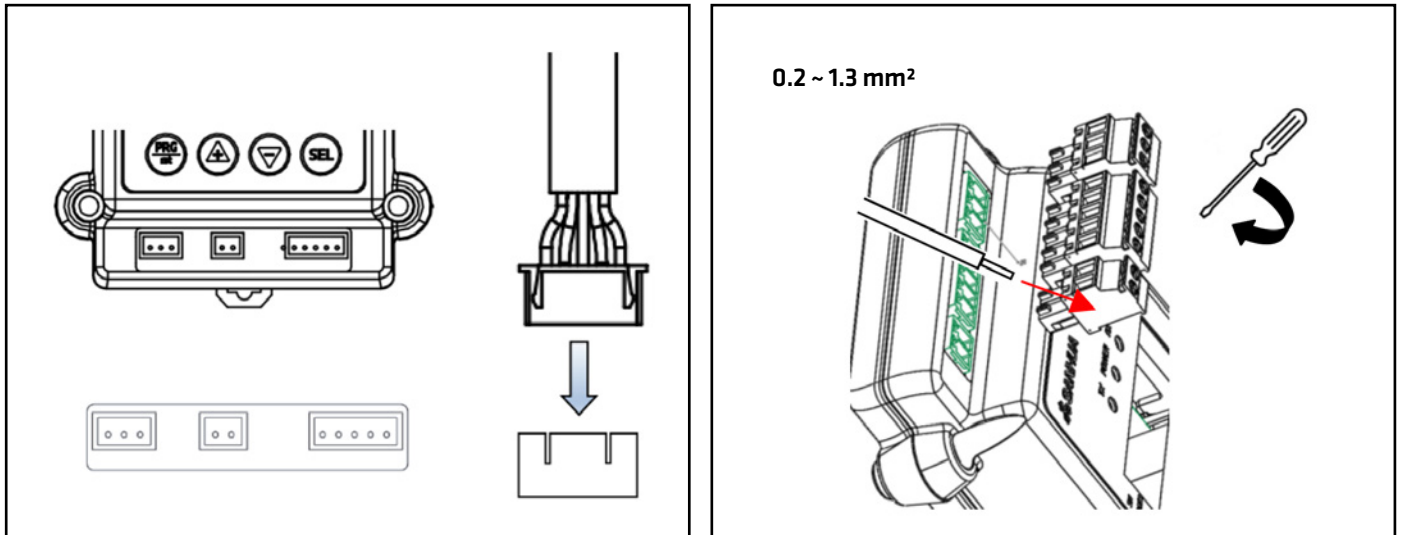

| Type | Function | Label | Description |
|--------------------|---------------------------------|-----------|-------------------------------------------------------------------------------------------------------------|
| Pluggable terminal | Power supply | 24Vac/Vdc | +24V AC24V / DC24V+ |
| | | | -24V AC24V / DC24V- |
| | Compressor signal and comm port | RUN | GND Passive switching signal, open or close synchronously with the compressor, close when using manual mode |
| | | | S/W |
| | | RS485 | GND GND |
| | | | B- TRX-(B) |
| | Auxiliary relay output | AUX-RLY | A+ TRX+(A) |
| | | | N.O. Normally Open contact |
| | | | COM Common |
| | | | N.C. Normally Open contact |
| XHP terminal | Pressure sensor | P-SENS | Vcc Power: YCQB: +5V (RED) YCQC: 10-30Vdc |
| | | | S1 S1 YCQB: 0.5-3.5V (White) YCQC: 4-20mA |
| | | | GND GND YCQB: GND (Black) YCQC: N/A |
| | Temp. sensor | T-SENS | S2 NTCSK/B3970 |
| | | | GND |
| | EEV output | EEV MOTOR | A |
| | | | B |
| | | | \bar{A} |
| \bar{B} | | | |
| COM | | | |

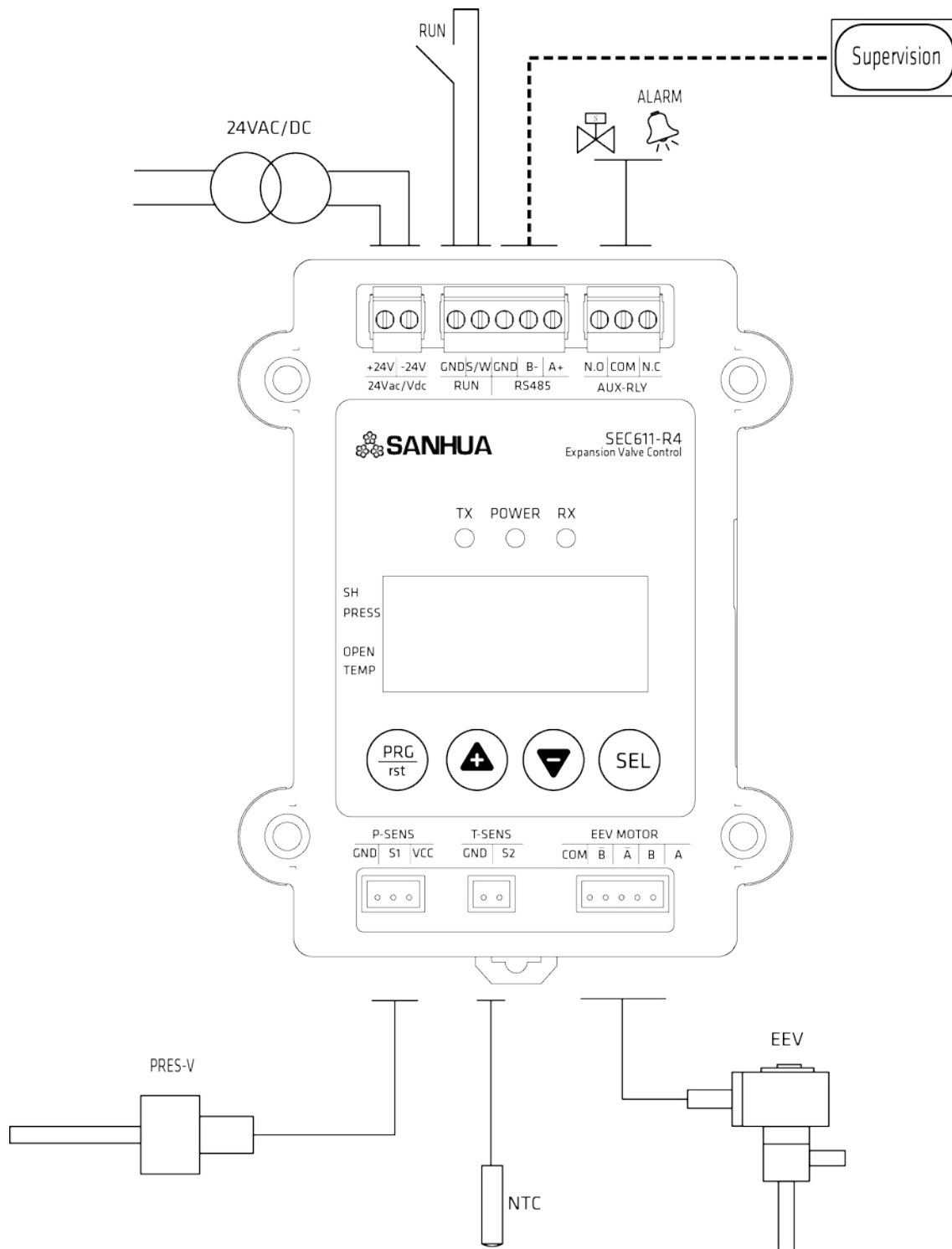

Safety Tips:

1. Do not turn on the power before completing the wiring, cut off the power before changing the wiring.
2. The RUN port (compressor signal) is a passive port. If add a voltage it may cause the controller burn out.
3. Ultracapacitor please series connected to the power supply wire. (Coming soon)
4. If you use a transformer, please ensure the minimum power is 15 VA (for 1 controller + 1 EEV).
5. Min/max wire diameter: 0.2 ~1.3 mm²
6. 24Vdc or 24Vac for SEC611, 24Vdc only for SEC612.

4. DIP SW Setting

All DIP switches are OFF in default mode (suitable for most applications). There are 4 DIP switches, 2, 3 used as a group for selecting EEV type, 1, 4 used as a group for selecting controller operating mode.

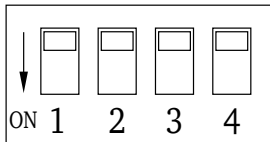

a. EEV type selecting

EEV total steps, excitation speed and excitation mode is determined by the DIP SW2, 3

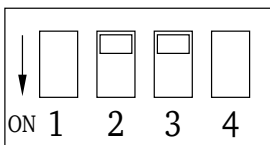

(Default mode)
DIP SW2: OFF, DIP SW3: OFF
1-2 phase, 500 steps, 30pps

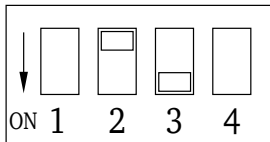

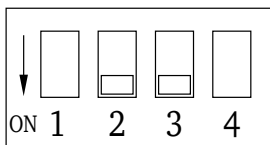

DIP SW2: OFF, DIP SW3: ON
2phase, 2000 steps, 100PPS



DIP SW2: ON, DIP SW3: ON
Custom mode, set by parameter
table 3

b. Control method selecting

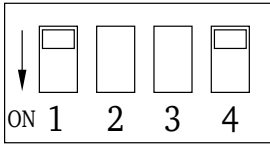
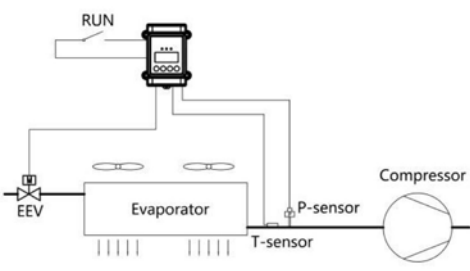
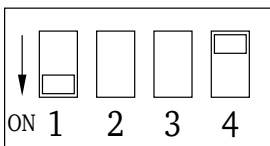
Control method determined by the DIP SW1, 4

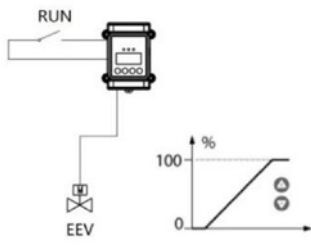
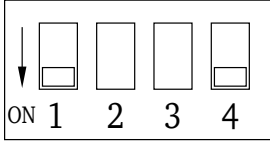
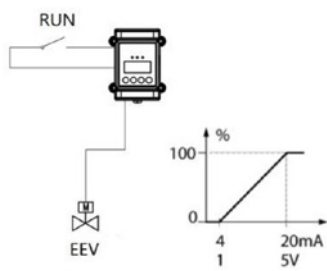
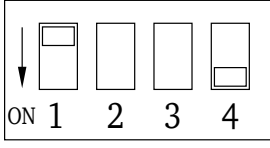
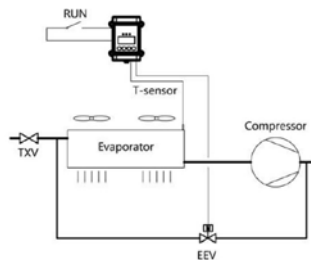
| DIP SW position | Description | Schematic |
|-------------------------------------------------------------------------------------|-------------------------------------------------------------------------------------------------------------------------------------------------------------------------------------------------------------------------------------------------------------------------------------------------------------------------------------------------|---------------------------------------------------------------------------------------|
|  | <ul style="list-style-type: none"> - DIP SW1: OFF, DIP SW4: OFF - Superheat control (Default mode) - Temp./pressure signal ensures system SH stable |  |
|  | <ul style="list-style-type: none"> - DIP SW1: ON, DIP SW4: OFF - Manual operation - Use   Button directly controls the valve opening ratio |  |
|  | <ul style="list-style-type: none"> - DIP SW1: ON, DIP SW4: ON - Drive mode - Use 4-20mA or 1-5V analog signal control |  |
|  | <ul style="list-style-type: none"> - DIP SW1: OFF, DIP SW4: ON - Hot gas bypass (temperature control) |  |

Note:

1. While using the manual /drive mode, keep the compressor RUN signal always ON.
2. In drive mode, external 4-20mA or 1-5V analog signal is input through the pressure sensor port.

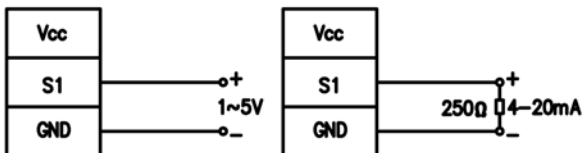

5. Buttons and operation

a. Screen introduction

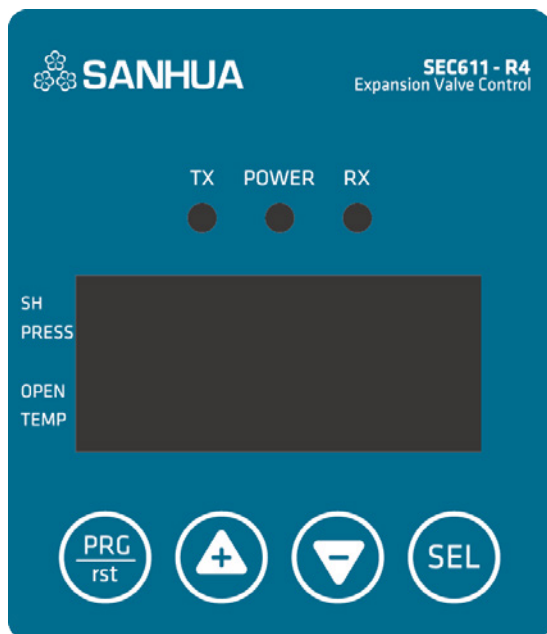

| LED | Description |
|---------|----------------------------------|
| SH | Display current superheat |
| PRESS | Display pressure sensor value |
| OPEN | Display current EEV opening |
| TEMP | Display temperature sensor value |
| oC /bar | Unit of temp./pressure |
| | Lighting when alarming |
| | Flickering at communication mode |
| POWER | Lighting at power up |
| TX,RX | Flickering at communication |

Use button can switch the display on screen among superheat/pressure/valve opening/temperature (current display is indicated by the cursor pointer)

b. Buttons introduction



Enter the parameter setting interface / return parameter list



Switch screen display parameters, increase/decrease parameters



Confirm key, parameter switch in parameter table, long press save parameter

c. Set/change parameters

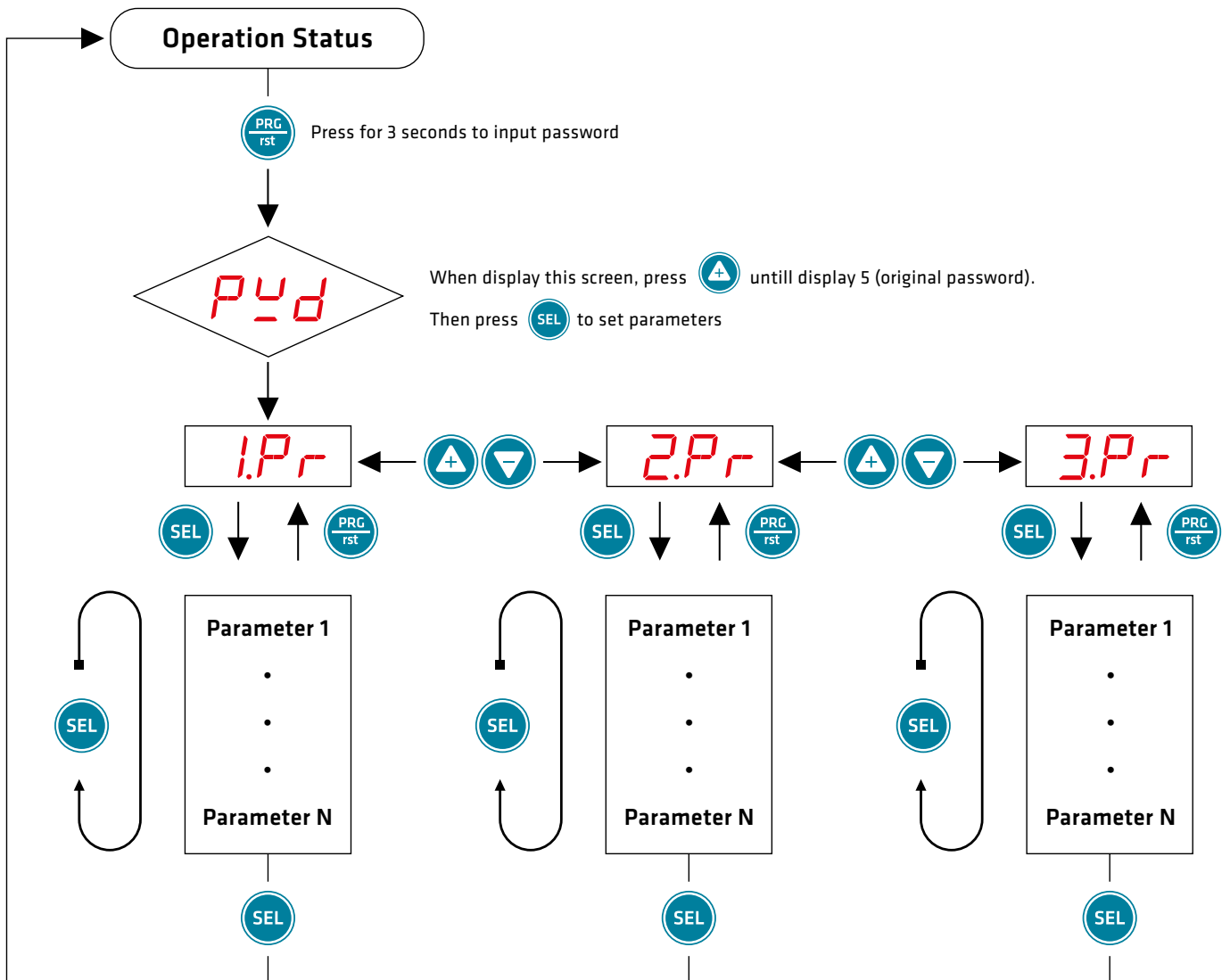

1. During operating status, long press **PRG/rst** for more than 3s, enter parameter setting mode
2. When screen show **P y d**, press **▲** until screen display 5 (original password), then press **SEL** enter parameters table list
3. **1.Pr** means parameters table1, press **▲** **▼** can select **2.Pr** or **3.Pr** (switching parameter table)
4. After selected parameters table, press **SEL** enter the table, if you want to switch other parameter tables, press **PRG/rst** return to the parameter table select list
5. In parameters table, screen will directly display the parameter code, press **SEL** can switch the code in parameters table
6. When the screen displays the parameter code which you want to modify, press **▲** **▼** can modify parameters directly, and press **SEL** will turn to next parameter or press **PRG/rst** return to the parameter table select list
7. After finish modifying, long press **SEL** for 3s will save all settings and return to the operating interface.

d. Main parameter setting

1. Refrigerant selection

Refrigerant data is in *2.Pr*

| Add. | Code | Description | Default |
|-------|------------|-------------|---------|
| 40062 | <i>rFY</i> | Refrigerant | 0(R22) |

Now 26 kinds refrigerants is available in controller as below:

| | | | | | | | |
|----------|---------|-----------|---------|-----------|-----------|-----------|-------|
| 0 | R22 | 7 | R1234YF | 14 | R744(CO2) | 21 | R124 |
| 1 | R404A | 8 | R290 | 15 | R744(N2O) | 22 | R717 |
| 2 | R410A | 9 | R450A | 16 | R32 | 23 | R407H |
| 3 | R134A | 10 | R513A | 17 | R245FA | 24 | R454C |
| 4 | R407C | 11 | R448A | 18 | R23 | 25 | R455A |
| 5 | R507 | 12 | R449A | 19 | R407A | | |
| 6 | R1234ZE | 13 | R452A | 20 | R407F | | |

2. Target superheat setting

Target superheat is in *1.Pr*

| Add. | Code | Description | Default |
|-------|-----------|------------------|---------|
| 40001 | <i>SH</i> | Target superheat | 6 |

If the target SH is too small, may cause liquid hammer in compressor; if the target value is too large, the evaporator energy efficiency will be very low.

3. Start open ratio and duration time

You can find it in *1.Pr*

| Add. | Code | Description | Default |
|-------|------------|--------------------------------|---------|
| 40003 | <i>blr</i> | Start open ratio | 0 |
| 40004 | <i>sdL</i> | Start open ratio duration time | 0 |

When controller receives compressor RUN signal, EEV will keep the start opening ratio for the duration time.

4. Pump down function

| Add. | Code | Description | Default |
|-------|------------|-------------------------------------------|---------|
| 40025 | <i>Pd</i> | Select pump down function and delay time | -1(OFF) |
| 40026 | <i>PdP</i> | Pressure set-point for stopping pump down | 0.5 |

If 40025 value is not -1, pump down function is ON



RUN signal = ON => Compressor is ON

RUN signal = OFF (need main controller to cut off) => EEV will close

when low pressure = 40026 bar or delay time = 40025 seconds, the Output Relay changes its position and will inform to cut Off the compressor

5. Reset to factory settings

| Add. | Code | Description | Default |
|------|------------|-------------|---------|
| | <i>rSt</i> | Reset | 0 |

Reset is in *2Pr* menu, use   to find the parameter *rSt*, input backup-password 913 and long press , all parameters reset to the default from factory.

6. Alarm mode

| Code | Description | Code | Description |
|------------|------------------------------------|------------|---------------------------------|
| <i>StP</i> | RUN signal disconnected | <i>nōP</i> | MOP high pressure alarm |
| <i>PoP</i> | Pressure transmitter disconnected | <i>LoP</i> | LOP Low pressure alarm |
| <i>PSt</i> | Pressure transmitter short circuit | <i>HSH</i> | High superheat alarm |
| <i>tōP</i> | Temperature sensor disconnected | <i>LSH</i> | Low superheat alarm |
| <i>tSt</i> | Temperature sensor short circuit | <i>FrE</i> | Low temperature freezing alarm |
| | | <i>888</i> | Supply voltage out of tolerance |

Note *StP* is not alarm, just reminding the compressor RUN signal is disconnected.

Alarm manual reset button is on side face of SEC (EEV driver) shell.

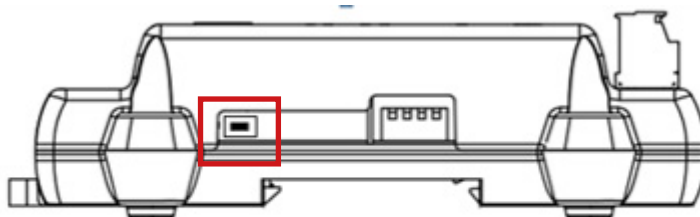

7. Parameters Table

1. *IPr* Refrigerant data is in

| Add. | Description | Code | Unit | Step | Min. | Max. | Default |
|-------|-------------------------------------------|------------|---------------------------------------------|------|------|------|---------|
| 40001 | Superheat set point | <i>SH</i> | K | 0.1 | 0.5 | 30 | 6 |
| 40003 | Start open ratio | <i>blr</i> | % | 1 | 0 | 100 | 0 |
| 40004 | Start open ratio duration time | <i>Sdt</i> | Sec | 1 | 0 | 600 | 0 |
| 40005 | P: Proportional gain | <i>dFr</i> | % | 0.1 | 0.1 | 99.9 | 3 |
| 40006 | I: Integral time | <i>irt</i> | Sec | 1 | 0 | 999 | 20 |
| 40007 | D: Derivative time | <i>drt</i> | Sec | 1 | 0 | 999 | 4 |
| 40008 | Low SH alarm mode | <i>LS</i> | 0=No use 1=automatic return 2=manual return | | | | 1 |
| 40009 | Low SH alarm value | <i>LSH</i> | K | 0.1 | 0.5 | 30 | 0.5 |
| 40010 | Low SH alarm delay time | <i>LSd</i> | Sec | 1 | 1 | 300 | 15 |
| 40011 | Clear low SH alarm | <i>LSF</i> | K | 0.1 | 1 | 30.5 | 3 |
| 40012 | MOP alarm mode | <i>MP</i> | 0=No use 1=automatic return 2=manual return | | | | 1 |
| 40013 | MOP alarm pressure | <i>MP</i> | bar | 0.1 | -1 | 50 | 9 |
| 40014 | MOP alarm delay time | <i>MPd</i> | Min | 1 | 1 | 15 | 1 |
| 40015 | Clear MOP alarm | <i>MPF</i> | bar | 0.1 | -1 | 50 | 8 |
| 40016 | High SH alarm mode | <i>HS</i> | 0=No use 1=automatic return 2=manual return | | | | 0 |
| 40017 | High SH alarm value | <i>HSH</i> | K | 1 | 10 | 40 | 30 |
| 40018 | High SH alarm delay time | <i>HSd</i> | Min | 1 | 1 | 600 | 3 |
| 40019 | Clear high SH alarm | <i>HSF</i> | K | 0.1 | 7 | 37 | 27 |
| 40021 | Freeze prevention alarm mode | <i>Fr</i> | 0=No use 1=automatic return 2=manual return | | | | 0 |
| 40022 | Freeze prevention alarm value | <i>FrE</i> | °C | 1 | -40 | 40 | 0 |
| 40023 | Freeze prevention alarm delay time | <i>FrD</i> | Sec | 1 | 5 | 200 | 30 |
| 40024 | Clear freeze prevention alarm | <i>FrF</i> | °C | 1 | -37 | 43 | 3 |
| 40025 | Select pump down function and delay time | <i>Pd</i> | Sec | 1 | 0 | 180 | -1(OFF) |
| 40026 | Pressure set-point for stopping pump down | <i>PdP</i> | bar | 0.1 | -0.5 | 18 | 0.5 |
| 40027 | Pressure low limit alarm mode | <i>LP</i> | 0=No use 1=automatic return 2=manual return | | | | 0 |
| 40028 | Pressure low limit alarm value | <i>LoP</i> | bar | 0.1 | -0.8 | 17.7 | 0 |
| 40029 | Low limit pressure alarm delay time | <i>LPd</i> | Sec | 1 | 5 | 200 | 5 |
| 40030 | Clear low limit pressure alarm | <i>LPF</i> | bar | 0.1 | -0.5 | 18 | 0.3 |

1) Alarm setting

When alarm setting is ON, if system pressure/temperature exceeds/below the set alarm value and keep more than the delay time, the controller will generate an alarm and act accordingly

2.2.P.r (Parameters Table2)

| Add. | Description | Code | Unit | Step | Min. | Max. | Default |
|-------|-----------------------------------|------------|---------------------------------------------------------------------------------------------------------------------------------------------------------------------------------------------------------------------------------------------------|------|------|------|-----------------------------|
| 40061 | Password | <i>PCd</i> | / | 1 | 0 | 999 | 5 |
| 40062 | Refrigerant | <i>rFY</i> | 0=R22 1=R404A 2=R410A 3=R134a 4=R407C 5=R507 6=R1234ze 7=R1234yf 8=R290 9=R450A 10=R513A 11=R448A 12=R449A 13=R452A 14=R744(CO2) 15=R744(N2O) 16=R32 17=R245fa 18=R23 19=R407A 20=R407F 21=R124 22=R717 23=R407H 24=R454C 25=R455A | | | | 0 |
| 40063 | Pressure sensor MAX. range | <i>PSH</i> | bar | 1 | 0 | 99 | 12(Current) 20(Voltage) |
| 40064 | Pressure sensor MIN. range | <i>PSL</i> | bar | 1 | -1 | 99 | -1(Current) 0(S Voltage) |
| 40065 | Pressure sensor offset correction | <i>PCr</i> | K | 0.1 | -9.9 | 9.9 | 0 |
| 40066 | Temp. sensor offset correction | <i>tCr</i> | K | 0.1 | -20 | 19.9 | 0 |
| 40069 | Jerk control ratio | <i>JEY</i> | | 0.1 | 0.1 | 100 | 100 |
| 40070 | EEV open ratio upper limit | <i>oPH</i> | % | 1 | 0 | 100 | 100 |
| 40071 | EEV open ratio lower limit | <i>oPL</i> | % | 1 | 0 | 100 | 0 |
| 40072 | Sensor input filter time | <i>oII</i> | / | 0.1 | 1 | 99.9 | 1 |
| 40073 | EEV compulsory open ratio | <i>UCr</i> | % | 0.1 | 0 | 100 | OFF(-1) |
| 40076 | Display mode | <i>dis</i> | 0=1~4 rotation / 1= Superheat 2=Evaporator outlet pressure / 3= Expansion valve open ratio 4= Evaporator outlet temperature / 5= Saturation temperature | | | | 1 |
| 40077 | Run/stop method | <i>rnt</i> | 0= Always run / 1= Digital input 2= Communication Run | | | | 1 |
| 40078 | CommunicationID setup | <i>Id</i> | / | 1 | 1 | 254 | 1 |
| 40079 | Communication speed setup | <i>bdr</i> | 48(0)=4800 96(1)=9600 192(2)=19200 384(3)=38400 | | | | 96 |
| | Reset | <i>rSt</i> | / | 1 | 0 | 999 | 0 |

1) set *rSt* to password value (default 5), and then long press  the controller will factory reset.

3. *3Pr* (Parameters Table3)

| Add. | Description | Code | Unit | Step | Min. | Max. | Default |
|-------|---------------------------------|-----------------------|---------------------------------------------------------------------------------------------------------------------------|------|-------------------------|------|---------|
| 40041 | Hold current | <i>E_HH</i> | 0=OFF | | 1=ON | | 0 |
| 40042 | Expansion valve excitation type | <i>E_Hd</i> | 1-2(0)=1-2 phase excitation | | 2(1)=2 phase excitation | | 1-2 |
| 40043 | Expansion valve total pulse | <i>E_HP</i> | pulse | 1 | 10 | 999 | 50 |
| 40044 | Expansion valve open pulse | <i>E_Ho</i> | pulse | 1 | 0 | 999 | 30 |
| 40045 | EEV drive speed (PPS) | <i>E_HS</i> | 10(0)=10PPS 20(1)=20PPS 30(2)=30PPS 50(3)=50PPS 80(4)=80PPS 100(5)=100PPS 200(6)=200PPS 250(7)=250PPS 500(8)=500PPS | | | | 30(2) |

- 1) Parameter Table 3 is usually not use, SANHUA standard EEV can directly set by the DIP SW.
If you want modify parameters table 3, please change DIP SW first. (See page 5)
- 2) Because the controller screen display maximum value is 999, so 40043 EEV total steps pulse 50 means 500 steps.

8. Communication Protocol

a. Specification

| Item | Description |
|------------------------------|-----------------------------------------------------------|
| Transmission line connection | Multiple line |
| Communication method | RS485 (2-wire, half-duplex) |
| Baud-rate | Default 9600BPS |
| Parity, Data, Stop bit | None, 8 data, 1 stop |
| Protocol Type | Modbus RTU Mode |
| Function Code | Read Hold Registers (0×03) /Preset Single Register (0×06) |
| Max. Read Word | 32word |
| Media Type | Belden 9841/9842, LG LIREV-AMESB |
| Poll interval | 100ms |

b. Status of Communication table

| Add. | Function | Unit | Type | S | SEC601 | MMI |
|-------|--------------------------------|------|---------|--------|--------------------|-------|
| 40073 | EEV compulsory open ratio | - | Analog | INT 16 | 0.0-100.0 | ×10 |
| 40099 | Reset command | - | Analog | INT 16 | 0:OFF | 1:ON |
| 40101 | Run/Stop input | - | Analog | INT 16 | 0:Stop | 1:Run |
| 40102 | Operation status | - | Analog | INT 16 | Refer to below bit | |
| Bit0 | Operation status of EEV | - | Digital | bit | 0:OFF | 1:ON |
| Bit1 | Aux. relay output | - | Digital | bit | 0:OFF | 1:ON |
| 40110 | Alarm status | - | Analog | INT 16 | Refer to below bit | |
| Bit0 | Press. sensor disconnection | - | Digital | bit | 0:OFF | 1:ON |
| Bit1 | Press. sensor short circuit | - | Digital | bit | 0:OFF | 1:ON |
| Bit2 | Temp. sensor disconnection | - | Digital | bit | 0:OFF | 1:ON |
| Bit3 | Temp. sensor short circuit | - | Digital | bit | 0:OFF | 1:ON |
| Bit6 | MOP alarm | - | Digital | bit | 0:OFF | 1:ON |
| Bit7 | Low limit pressure alarm | - | Digital | bit | 0:OFF | 1:ON |
| Bit8 | High superheat alarm | - | Digital | bit | 0:OFF | 1:ON |
| Bit9 | Low superheat alarm | - | Digital | bit | 0:OFF | 1:ON |
| Bit10 | Freezing Protection alarm | - | Digital | bit | 0:OFF | 1:ON |
| 40111 | Present Superheat | K | Analog | INT 16 | | ×10 |
| 40112 | Present saturation temperature | C | Analog | INT 16 | | ×10 |
| 40113 | Present pressure | bar | Analog | INT 16 | -1.0~1.0 | ×10 |
| 40114 | Present temperature | C | Analog | INT 16 | -100.0~100.0 | ×10 |
| 40116 | EEV open ratio | % | Analog | INT 16 | 0.0~100.0 | ×10 |

SANHUA