

SHF-R SERIES

4 WAY REVERSING VALVE

SHF-R series four-way reversing valves are applicable for heat pump systems such as central, unitary and room air conditioners to realize switching between cooling mode and heating mode by changing the flow path of refrigerant. The Versions SHF-R use a special internal slide material able to resist to refrigerant temperatures until +150°C, making them suitable for R32 systems without liquid injection and high discharge temperatures.

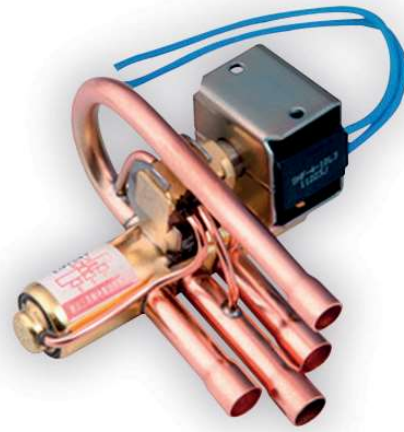

FEATURES

- SUITABLE FOR R32 SYSTEMS WITH HIGH DISCHARGE TEMPERATURES
- SUITABLE FOR COOLING CAPACITIES FROM 41.5 TO 116.7 KW (R32, CONDITION 2, $\Delta P=0.1\text{BAR}$)
- SEVERAL DESIGNS AVAILABLE
- CERTIFIED ACCORDING PED CAT.II BY TUV RHEINLAND

GENERAL SPECIFICATION

- Applicable for R32; also compatible with all common HCFC, HFC, HFO, HC refrigerants such as: R22, R134a, R404A, R407A/C/F, R410A, R507A, R448A, R449A, R450A, R452A, R513A, R1234yf, R1234ze, R454A/B/C, R455A, R290, R1270, R600a
- Medium temperature TS min./max.: -30°C / +150°C
- Ambient temperature min./max.: -30°C / +50°C
- Relative humidity: 0 to 95% RH
- Max. operating pressure PS = 4.9 MPa (49 bar)
- Installation position:
 - Coil upwards or with body axis in horizontal alignment
 - Flow direction according to installation instruction
- Certifications: Manufacturer declaration according to LVD or PED Third part Certification according to PED directive cat.II UL/CSA not available (on request)

SHF-R SERIES

4 WAY REVERSING VALVE

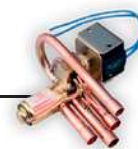

TABLE 1: SHF-R MODEL LIST

General Characteristics											
Valve Model	Product Number	Type of System [Variable or Fixed Speed]	Ø Port	Kv	Connections ODF		MOP	OPD		PED Category	
					ØD	ØE/S/C		Max.	Min.	Fluid	Fluid
			[mm]	[m³/h]	[inch]	[inch]	[MPa]	[MPa]	[MPa]	Group 2	Group 1
SHF-35R-47	On Request	Variable & Fixed	20	12,7	1/2	7/8	4,9	3,6	0,1	4,3	4,3
SHF-35R-57	On Request	Variable & Fixed	20	12,7	5/8	7/8	4,9	3,6	0,1	4,3	4,3
SHF-35R-59	On Request	Variable & Fixed	20	12,7	5/8	1 1/8	4,9	3,6	0,1	4,3	4,3
SHF-35R-67	10325061102	Variable & Fixed	20	12,7	3/4	7/8	4,9	3,6	0,1	4,3	4,3
SHF-35R-69	On Request	Variable & Fixed	20,9	12,7	3/4	1 1/8	4,9	3,6	0,1	4,3	4,3
SHF-35R-79	10325061602	Variable & Fixed	20,9	12,7	7/8	1 1/8	4,9	3,6	0,1	4,3	4,3
SHF-50R-79	10325061702	Variable & Fixed	22,8	18,3	7/8	1 1/8	4,9	3,6	0,1	4,3	4,3
SHF(L)-70R-810	On Request	Variable & Fixed	28,6	25,3	1	1 1/4	4,9	3,6	0,15	4,3	II
SHF(L)-70R-810-01	10325062102	Variable & Fixed	28,6	25,3	1	1 1/4	4,9	3,6	0,15	4,3	II
SHF(L)-70R-911	10325063902	Variable & Fixed	28,6	25,3	1 1/8	1 3/8	4,9	3,6	0,15	4,3	II
SHF(L)-70R-911-01	10325061202	Variable & Fixed	28,6	25,3	1 1/8	1 3/8	4,9	3,6	0,15	4,3	II
SHF(L)-70R-913-05	On Request	Variable & Fixed	28,6	25,3	1 1/8	1 5/8	4,9	3,6	0,15	I	II
SHF(L)-70R-913-03	10325061802	Variable & Fixed	28,6	25,3	1 1/8	1 5/8	4,9	3,6	0,15	I	II
SHF(L)-100R-911	On Request	Variable & Fixed	35,7	36,1	1 1/8	1 3/8	4,9	3,6	0,15	I	II
SHF(L)-100R-911-01	On Request	Variable & Fixed	35,7	36,1	1 1/8	1 3/8	4,9	3,6	0,15	I	II
SHF(L)-100R-913	On Request	Variable & Fixed	35,7	36,1	1 1/8	1 5/8	4,9	3,6	0,15	I	II
SHF(L)-100R-913-01	On Request	Variable & Fixed	35,7	36,1	1 1/8	1 5/8	4,9	3,6	0,15	I	II
SHF(L)-100R-1012	On Request	Variable & Fixed	35,7	36,1	1 1/4	1 1/2	4,9	3,6	0,15	I	II
SHF(L)-100R-1012-01	10325061002	Variable & Fixed	35,7	36,1	1 1/4	1 1/2	4,9	3,6	0,15	I	II
SHF(L)-100R-1013	On Request	Variable & Fixed	35,7	36,1	1 1/4	1 5/8	4,9	3,6	0,15	I	II
SHF(L)-100R-1013-01	10325061902	Variable & Fixed	35,7	36,1	1 1/4	1 5/8	4,5	3,6	0,15	I	II

SHF-R SERIES

4 WAY REVERSING VALVE



NOMINAL OPERATING CONDITIONS

Nominal Operating Conditions	Condition 1	Condition 2
Condensing Temperature t_c	38°C	54,4°C
Evaporating Temperature t_e	5°C	7,2°C
Superheat Δt_{sc}	5K	5K
Subcooling Δt_{sr}	0K	5K

Notes for Capacity Selection Tables: 1) Pressure drop is valid for flow on low pressure side (from ØC to ØS or from ØE to ØS)

Capacity Selection Table								
Valve Size	Nominal Cooling Capacity (condition 1)							
	R32		R410A		R134a		R404A / R507	
	$\Delta P: 0,1$ bar	$\Delta P: 0,2$ bar	$\Delta P: 0,1$ bar	$\Delta P: 0,2$ bar	$\Delta P: 0,1$ bar	$\Delta P: 0,2$ bar	$\Delta P: 0,1$ bar	$\Delta P: 0,2$ bar
	[kW]	[kW]	[kW]	[kW]	[kW]	[kW]	[kW]	[kW]
SHF-35R	44,3	62,6	34,4	48,6	22,0	31,1	24,2	34,2
SHF-50R	63,8	90,2	49,6	70,1	31,7	44,8	34,8	49,2
SHF(L)-70R	88,2	124,7	68,5	96,9	43,8	62,0	48,1	68,0
SHF(L)-100R	124,5	176,0	96,7	136,7	61,8	87,5	67,9	96,0

Capacity Selection Table								
Valve Size	Nominal Cooling Capacity (condition 2)							
	R32		R410A		R134a		R404A / R507	
	$\Delta P: 0,1$ bar	$\Delta P: 0,2$ bar	$\Delta P: 0,1$ bar	$\Delta P: 0,2$ bar	$\Delta P: 0,1$ bar	$\Delta P: 0,2$ bar	$\Delta P: 0,1$ bar	$\Delta P: 0,2$ bar
	[kW]	[kW]	[kW]	[kW]	[kW]	[kW]	[kW]	[kW]
SHF-35R	41,5	58,7	31,2	44,1	20,4	28,9	21,1	29,9
SHF-50R	59,8	84,6	45,0	63,6	29,5	41,7	30,5	43,1
SHF(L)-70R	82,7	116,9	62,2	87,9	40,7	57,6	42,1	59,6
SHF(L)-100R	116,7	165,0	87,7	124,1	57,5	81,3	59,4	84,1

SHF-R SERIES

4 WAY REVERSING VALVE



DIMENSIONS - VALVES

Dimensions - Valves												
Valve Model	Valve Style	L	A	B	C	D	E	F	G	H	Angle α	Weight
		[mm]	[mm]	[mm]	[mm]	[mm]	[mm]	[mm]	[mm]	[mm]	[°]	[kg]
SHF-35R-47	D1	212,2	82	87	100	-	-	33	-	-	0	1,3
SHF-35R-57	D1	212,2	82	87	100	-	-	33	-	-	0	1,3
SHF-35R-59	D1	212,2	82	87	100	-	-	33	-	-	0	1,3
SHF-35R-67	D1	212,2	82	87	100	-	-	33	-	-	0	1,3
SHF-35R-69	D1	212,2	82	87	100	-	-	33	-	-	0	1,3
SHF-35R-79	D1	212,2	82	87	100	-	-	33	-	-	0	1,3
SHF-50R-79	D1	217	91	96	128	-	-	33	-	-	0	2,1
SHF(L)-70R-810	D1	303	111	117	131	-	-	46	-	-	0	3,1
SHF(L)-70R-810-01	F	303	111	117	154	-	-	46	58	-	0	3,1
SHF(L)-70R-911	D1	303	111	117	154	-	-	46	-	-	0	3,1
SHF(L)-70R-911-01	F	321	111	117	131	-	-	49	58	-	0	3,6
SHF(L)-70R-913-05	D1	321	111	117	131	-	-	49	-	-	0	3,6
SHF(L)-70R-913-03	F	321	111	117	131	-	-	49	58	-	0	3,6
SHF(L)-100R-911	D1	321	111	117	131	-	-	49	-	-	0	3,6
SHF(L)-100R-911-01	F	303	111	117	131	-	-	46	58	-	0	3,1
SHF(L)-100R-913	D1	303	111	117	154	-	-	46	-	-	0	3,1
SHF(L)-100R-913-01	F	303	111	117	154	-	-	46	58	-	0	3,1
SHF(L)-100R-1012	D1	321	111	117	131	-	-	49	-	-	0	3,6
SHF(L)-100R-1012-01	F	321	111	117	131	-	-	49	58	-	0	3,6
SHF(L)-100R-1013	D1	321	111	117	131	-	-	49	-	-	0	3,6
SHF(L)-100R-1013-01	F	321	111	117	131	-	-	49	58	-	0	3,6

SHF-R SERIES
4 WAY REVERSING VALVE

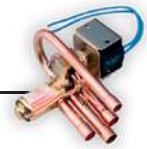

DIMENSIONS - VALVES

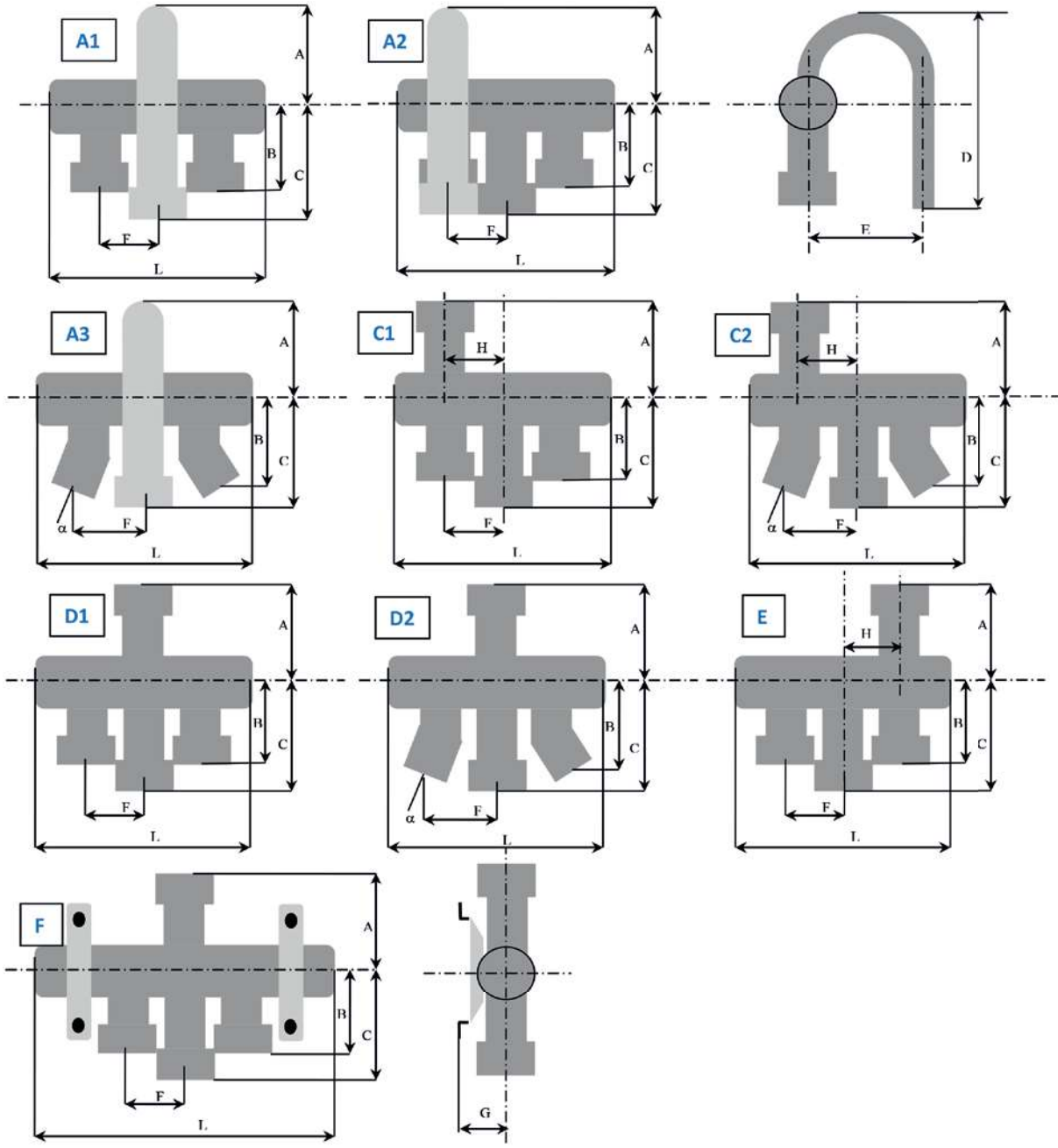

SHF-R SERIES 4 WAY REVERSING VALVE

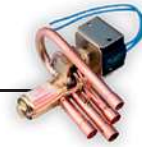

Coil Characteristics												
Coil Model ¹⁾	Winding Code	Part Number	Electrical Function/Connection Type	Cable Length	Power Supply	Rated Voltage	Power Consumption			Protection Clas	Insulat. Class	Max. Op. Temp.
							AC	AC	DC			
							50Hz	60Hz				
[mm]	[-]	[V]	[W]	[W]	[W]	[-]	[-]	[°C]				
SQ-A25 22G-00 0001	SHF-4-10L3	10805029102	Lead Wires	500	AC	220-240	4,5	3,5	-	IP54	B ²⁾	130
SQ-A25 200-00 0001	SHF-4-10L2	10805027002	Lead Wires	500	AC	200	4,5	3,5	-			
SQ-A25 100-00 0001	SHF-4-10L1	10805023602	Lead Wires	500	AC	100	4,5	3,5	-			
SQ-A25 11A-00 0001	SHF-4-10L4	10805150302	Lead Wires	500	AC	110-120	4,5	3,5	-			
SQ-A25 024-00 0001	SHF-4-10L5	10805227602	Lead Wires	500	AC	24	4,5	3,5	-			
SQ-A25 26H-00 0001	SHF-4-10L6	10805231902	Lead Wires	500	AC	265-277	4,5	3,5	-			
SQ-A25 22G-00 0870	SHF-4-10L3	10805240702	Lead Wires	1500	AC	220-240	4,5	3,5	-			
SQ-A25 11A-00 0840	SHF-4-10L4	10805240802	Lead Wires	1500	AC	110-120	4,5	3,5	-			
SQ-A25 024-00 0161	SHF-4-10L5	10805023002	Lead Wires	1500	AC	24	4,5	3,5	-			
SQ-A47 22G-00 0001	SHF-4-10FA5	10805263402	Spade (Faston) ³⁾	-	AC	220-240	6	5	-			
SQ-A47 220-00 0001	SHF-4-10FA1	10805273402	Spade (Faston) ³⁾	-	AC	220	6	5	-			
SQ-A47 11B-00 0001	SHF-4-10FA2	10805273302	Spade (Faston) ³⁾	-	AC	120	6	5	-			
SQ-A47 10A-00 0001	SHF-4-10FA3	10805268702	Spade (Faston) ³⁾	-	AC	100-110	6	5	-			
SQ-A47 024-00 0001	SHF-4-10FA4	10805263302	Spade (Faston) ³⁾	-	AC	24	6	5	-			
SQ-A47 26H-00 0001	SHF-4-10FA6	10805273502	Spade (Faston) ³⁾	-	AC	265-277	6	5	-			
SQ-D44 012-00 0001	SHF-4-10FA8	10805231802	Spade (Faston) ³⁾	-	DC	12	-	-	10			
SQ-D44 024-00 0001	SHF-4-10FA9	10805070102	Spade (Faston) ³⁾	-	DC	24	-	-	11			

- Note:**
- 1) Every coil is applicable to all above specified valve models
 - 2) Max ambient temperature up to + 50 °C
 - 3) Wire Harness for coil with Faston connector available as accessory

ACCESSORY

Wire Harness		
Model	Part Number	Cable Length [mm]
SQ-000000-090028	20805136301	1200
SQ-000000-090029	20805149201	2000

SHF-R SERIES 4 WAY REVERSING VALVE

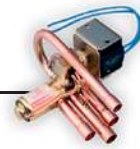

DIMENSIONS - COILS

Coils with Lead Wires (SQ-A25 Series)

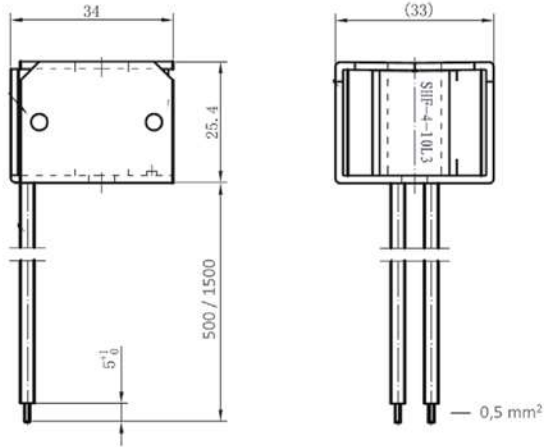

Bistable Coils (SQ-A/D27 Series)

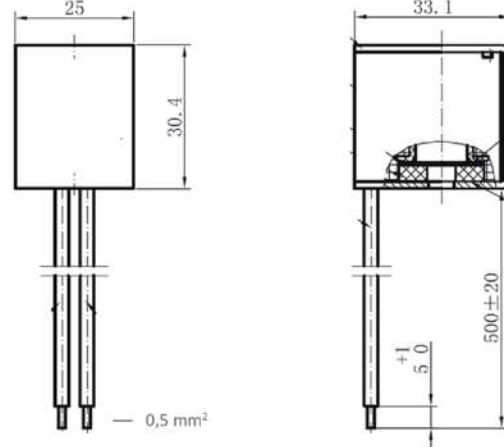

Coils with Spade Connections (SQ-A47 and SQ-D44 Series)

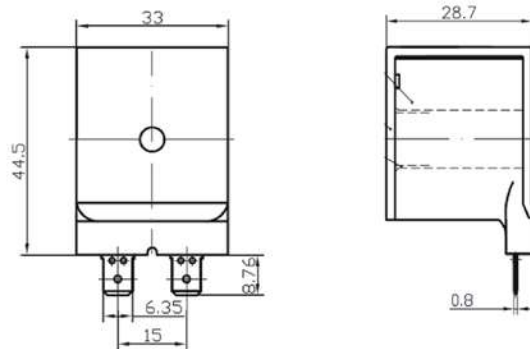

Wire Harness (SQ-000000-0900xx)

